

YT57

3 Hands / Date

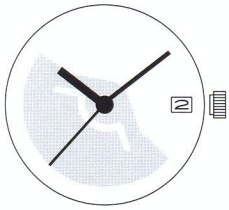

POWER STORAGE  
6 Months

H: 4.89mm

YT58

3 Hands / Day-Date

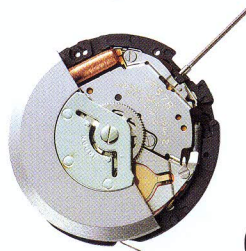
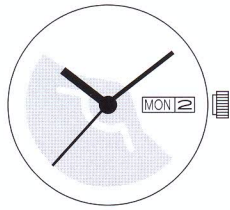

POWER STORAGE  
6 Months

H: 4.89mm



YT62

3 Hands / Date

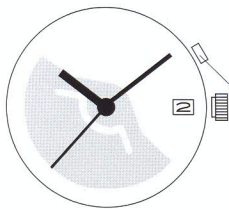

Power Storage Indicator



POWER STORAGE  
6 Months

H: 4.89mm

YT63

3 Hands / Day-Date

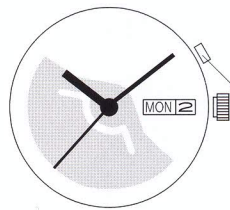

Power Storage Indicator

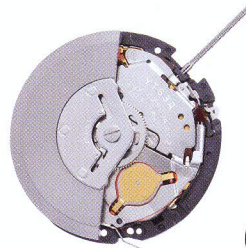

POWER STORAGE  
6 Months

H: 4.89mm

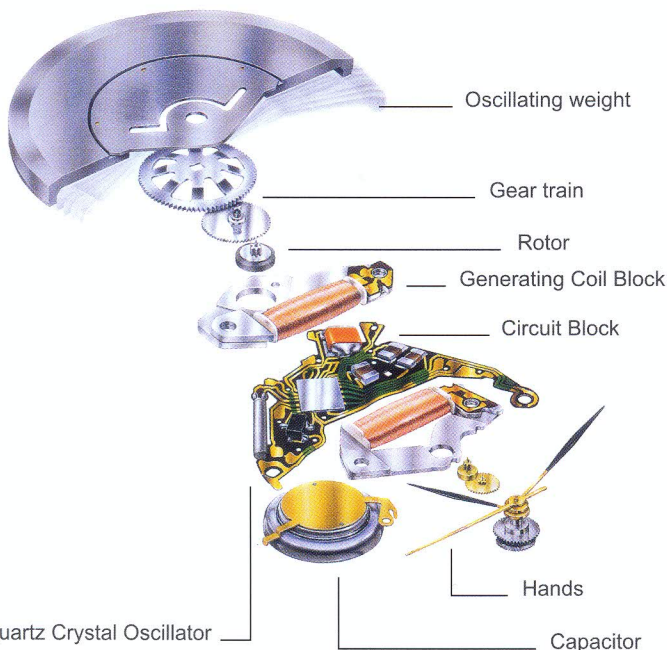
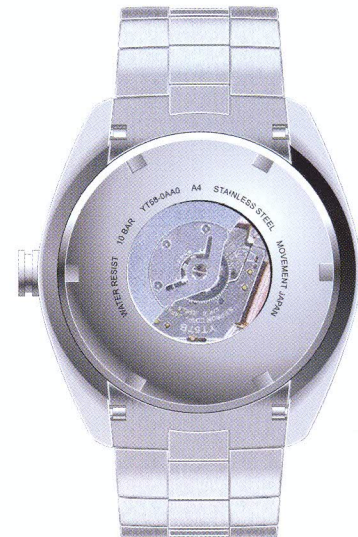

What's AGS?

AGS is the Automatic Generating System, the next-generation watch technology made possible by TMI's technical expertise.

- 1) Environment Protection
- 2) Innovation Technology
- 3) Natural Energy

How AGS works?

Movement of the wearer's arm rotates an oscillating weight that drives a rotor. A high-density coil transforms the magnetic charge from the rotor into electricity that powers the watch. A capacitor stores energy for use when it is required.