

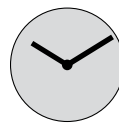

11 1/2^{mm}

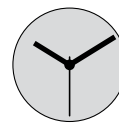

512



513 / 513S

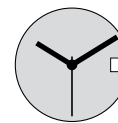

515 / 515S

Funktionen

Fonctions

Functions

Kaliber Calibre Caliber	Stellwellenpos. Pos. de tige Stem position	Funktionen Fonctions Functions
512 513, 513S	1	Normale Position / Position normale / Running position Zeiger stellen, Sekunden-Stopp mit Unterbruch der Motorimpulse
	2	Mise à l'heure, stop-seconde avec interruption des impulsions moteur Hand setting, stop-second with interruption of motor pulses
515, 515S	1	Normale Position / Position normale / Running position
	2	Datumskorrektur / Correction de la date / Date correction
	3	Zeiger stellen, Sekunden-Stopp mit Unterbruch der Motorimpulse Mise à l'heure, stop-seconde avec interruption des impulsions moteur Hand setting, stop-second with interruption of motor pulses

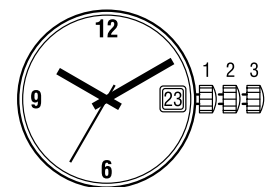

Batterie

Pile

Battery

Kaliber Calibre Caliber	Batterie Pile Battery	Spannung Voltage Tension	Artikelnummer RONDA Numero d'article RONDA Part number RONDA
512, 513, 513S, 515, 515S	371/SR920SW	1.55 V	3600.015.HGF

11 1/2''' 512, 513/513S, 515/515S

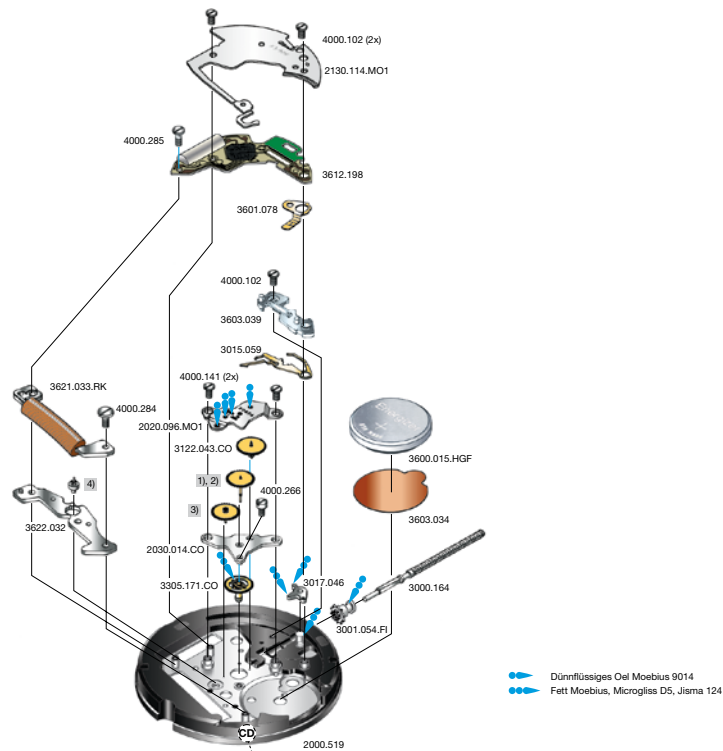

Code: Beispiel CD / exemple CD / exemple CD

Cal. 513 Werkseite / Côté mouvement / Movement side			
Plan No.	Bestandteile	Fournitures	Spare Parts
2000.519	Werkplatte	Platine	Main plate
2020.096.MO1	Räderwerkbrücke	Pont rouage	Train w. bridge
2030.014.CO	Zentrumbrücke	Pont centre	Centre bridge
2130.114.MO1	Modul-Abdeckp.	Couvre module	Module cover pl.
3000.164	Stellwelle	Tige	Stem
3001.054.FI	Kupplungstrieb	Pignon coulant	Sliding pinion
3015.059	Kuppl.-triebhebel	Bascule	Yoke
3017.046	Winkelhebel	Tirette	Setting lever
3122.043.CO	Kleinbodenrad	Roue moyenne	Third wheel
1)	Sekundenrad	Roue secondes	Second-wheel
3)	Zwischenrad	Roue interméd.	Intermed. wheel
3305.171.CO	Minutenrohr	Chaussée	Cannon pinion
3600.015.HGF	Batterie	Pile	Battery
3601.078	Batterie-Kontakt	Bride contact	Battery contact
3603.034	Batterie-Isolation	Isolateur pile	Battery insulation
3603.039	Deckplatte/ Ste.	Couvre mécan.	Setting lev. cover
3612.198	Modul	Module	Module
3621.033.RK	Spule	Bobine	Coil
3622.032	Stator	Stator	Stator
4)	Rotor	Rotor	Rotor
4000.102	Schraube	Vis	Screw
4000.141	Schraube	Vis	Screw
4000.266	Schraube	Vis	Screw
4000.284	Schraube	Vis	Screw
4000.285	Schraube	Vis	Screw

Cal. 513, 515, 515S

Bis Juni 2015 Jusqu' en Juin 2015 Untill June 2015	Ab Juli 2015 A partir de Juillet 2015 From July 2015
----------------------------------------------------------	------------------------------------------------------------

Code	2. Buchstabe ... C Second letter ... C 2 ^{ème} chiffre: ... C	2. Buchstabe: ab D Second letter: from D 2 ^{ème} chiffre: à partir de D
1)	3136.090.CO	3136.194.CO
3)	3147.019.CO	3147.092.CO
4)	3715.089.RK	3715.144.RK

Die obigen 3 Teile bilden jeweils eine Gruppe. Deshalb sind die 3 Teile jeder Gruppe nicht einzeln gegeneinander austauschbar.

Les 3 fournitures ci-dessous forment un groupe individuel. C'est pourquoi les 3 fournitures de chaque groupe ne sont pas interchangeables.

The 3 parts mentioned above are forming an individual group. Therefore the 3 parts of each group are not interchangeable.

Abweichungen / Divergences / Deviations

Cal. 515 Werkseite / Côté mouvement / Movement side			
Plan No.	Bestandteile	Fournitures	Spare Parts
3015.060	Kuppl.-triebhebel	Bascule	Yoke

Cal. 513S/515S Werkseite / Côté mouvement / Movement side			
Plan No.	Bestandteile	Fournitures	Spare Parts
3612.199	Modul	Module	Module
3621.036.RK	Spule	Bobine	Coil

Cal. 512 Werkseite / Côté mouvement / Movement side			
Plan No.	Bestandteile	Fournitures	Spare Parts
2030.012.CO	Zentrumbrücke	Pont centre	Centre bridge
2)	Sekundenrad	Roue secondes	Second-wheel
3)	Zwischenrad	Roue interméd.	Intermed. wheel
3305.210.CO	Minutenrohr	Chaussée	Cannon pinion
4)	Rotor	Rotor	Rotor

Cal. 512

Bis Juni 2015 Jusqu' en Juin 2015 Untill June 2015	Ab Juli 2015 A partir de Juillet 2015 From July 2015
----------------------------------------------------------	------------------------------------------------------------

Code	2. Buchstabe ... C Second letter ... C 2 ^{ème} chiffre: ... C	2. Buchstabe: ab D Second letter: from D 2 ^{ème} chiffre: à partir de D
2)	3136.093.CO	3136.196.CO
3)	3147.019.CO	3147.092.CO
4)	3715.089.RK	3715.144.RK

Die obigen 3 Teile bilden jeweils eine Gruppe. Deshalb sind die 3 Teile jeder Gruppe nicht einzeln gegeneinander austauschbar.

Les 3 fournitures ci-dessous forment un groupe individuel. C'est pourquoi les 3 fournitures de chaque groupe ne sont pas interchangeables.

The 3 parts mentioned above are forming an individual group. Therefore the 3 parts of each group are not interchangeable.

Werkaufbau

Assemblage

Assembling

11 1/2''' 515/515S

11 1/2''' 512, 513/513S

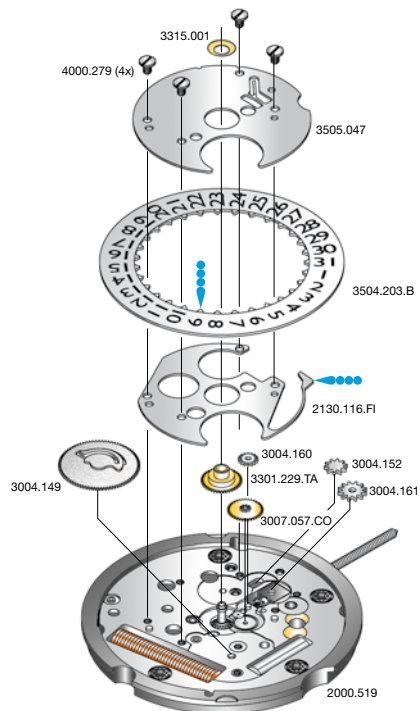

●●●●● Fett Moebius, Microgliss 14

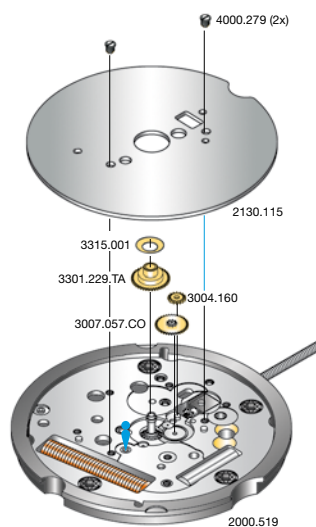

➡ Düninflüssiges Oel Moebius 9014

Cal. 515/515S Zifferblattseite / Côté cadran / Dial side			
Plan No.	Bestandteile	Fournitures	Spare Parts
2130.116.FI	Kalenderplatte	Plaque calendrier	Date ind. plate
3004.149	Datummitn.-rad	Renvoi entraîin.	Ind. driving wheel
3004.152	Umkehrad	Baladeur	Sliding gear
3004.160	Zeigerstellrad	Renvoi minuterie	Setting wheel
3004.161	Verbindungsrad-Kupplungtrieb	Renvoi pig. coulant	Sliding pinon setting wheel
3007.057.CO	Wechselrad	Minuterie	Minute wheel
3301.229.TA	Stundenrad	Canon	Hour wheel
3315.001	Spreizfeder	Clinquant	Washer
3504.203.B	Datumanzeiger	Bague	Date indicator
3505.047	Kal.-Abdeckplatte	Couvercle calend.	Date ind. cover
4000.279	Schraube	Vis	Screw

Cal. 512 Zifferblattseite / Côté cadran / Dial side			
Cal. 513/513S			
Plan No.	Bestandteile	Fournitures	Spare Parts
2130.115	Zeigerwerkplatte	Plaque maintien	Maintening plate
3004.160	Zeigerstellrad	Renvoi minuterie	Setting wheel
3007.057.CO	Wechselrad	Minuterie	Minute wheel
3301.229.TA	Stundenrad	Canon	Hour wheel
3315.001	Spreizfeder	Clinquant	Washer
4000.279	Schraube	Vis	Screw

Elektr. Messungen

Contrôles électriques

Electrical checking

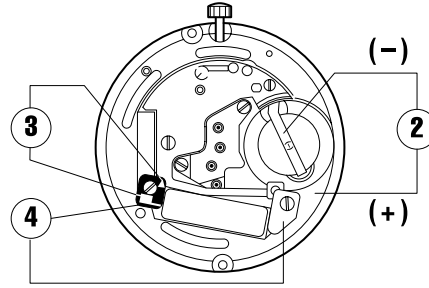
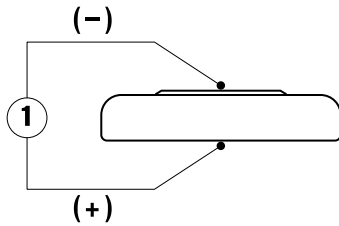

Kaliber Calibre Caliber	Pos. Pos. Pos.	Einheit Unité Unit	Messwerte Valeurs mesurées Measured values	Kontrolle Contrôle Check	Bemerkungen Remarques Remarks
512, 513, 515 513S, 515S	1	V	1,55	Batterie-Spannung Tension de la pile Battery voltage	Batterie herausnehmen und messen Enlever et mesurer la pile Remove battery for measuring
512, 513, 515 513S, 515S	2	µA	1,10–1,85 2,20–2,65	Stromaufnahme Consom. de courant Power consumption	Ohne Batterie, mit externer Speisung Sans pile, avec alimentation externe Without battery, with external power supply
512, 513, 515 513S, 515S	2	V	≤ 1,30	Funktionskontrolle bei Minimalspannung Contrôle de fonctionnement à tension minimale Check with lowest possible voltage	Ohne Batterie, mit externer Speisung Sans pile, avec alimentation externe Without battery, with external power supply
512, 513, 515 513S, 515S	3	KΩ	1,90–2,10 2,35–2,55	Spulenwiderstand Résistance de la bobine Resistance of the coil	Ohne Batterie Sans pile Without battery
512, 513, 515 513S, 515S	4	KΩ	∞	Spulenisolation Isolation de la bobine Coil insulation	Ohne Batterie Sans pile Without battery
512, 513, 515 513S, 515S		Sek./Monat sec./mois sec./month	- 10/+ 20	Induktivsonde 60 Sek. Senseur inductif 60 sec. Inductive sensor 60 sec.	Mit Batterie Avec pile With battery

Einschalen / Werkzeuge

Emboîtage / outils

Casing / tools

Nr. H 51x.1A



Nr. H 51x.1T



SWISS MADE & SWISS PARTS	
Schraube Vis Screw	

Zeigersetzen

Maximale Aufpresskraft:

- Stunden und Minutenzeiger: max. 40N
- Sekundenzeiger: max. 30N

Beim Zeigersetzen muss das Werk abgestützt werden.

Poser les aiguilles

Force de chassage maximale:

- Aiguilles des heure et des minutes: max. 40N
- Aiguille des secondes: max. 30N

Lors de la pose d'aiguilles, le mouvement doit être soutenu.

Hand setting

Maximal force:

- Hour and minute hands: max. 40N
- Second hand: max. 30N

The movement needs to be supported for hand setting.

Kal. 512, 513, 513S	Stellwelle entfernen	Kal. 515, 515S	Stellwelle entfernen
Beim Entfernen der Stellwelle muss sich die Stellwelle in Position 1 (gedrückt) befinden, bevor auf den Winkelhebel gedrückt wird.		Beim Entfernen der Stellwelle muss sich die Stellwelle in Position 2 befinden, bevor auf den Winkelhebel gedrückt wird.	
Kal. 512, 513, 513S	Enlever la tige	Kal. 515, 515S	Enlever la tige
En enlevant la tige, la tige doit se trouver en position 1 (poussée), avant de pousser sur la tirette.		En enlevant la tige, la tige doit se trouver en position 2 , avant de pousser sur la tirette.	
Kal. 512, 513, 513S	Stem removal	Kal. 515, 515S	Stem removal
For removal of the stem, the stem must be in position 1 (pressed in) prior to apply pressure to the setting lever.		For removal of the stem, the stem must be in position 2 prior to apply pressure to the setting lever.	